

INSTRUCTIONS TO ASSEMBLE THE ANIMAL TRAP

1. Remove the cable ties holding the trap closed. (Figure 1)
2. Holding the handle on top of the trap, slowly pull up the trap allowing it to fall into place. (Figure 2) The rear door should be pushed down and back at the rear of the trap. (Figure 3) the wire lock (small square U shaped wire) can be inserted through the designated holes (trap back side the secondary series holes) and door rings to ensure the door doesn't open.
3. Pull down the 'U' shaped support arms and fix them into the fixing clips located on the each side of the trap. These support arms must be fixed in place to support the trap. (Figure 4). If you find the support arms do not stay firmly in the fixing clips, use your fingers or pliers to squeeze the fixing clips closed to secure the support arms.
4. The trap should now be ready to connect the trap door to the foot plate. (Figure 5)
5. The curled bottom end of the Trip Plate Rod should be connected to the Trip Plate.

**Note – the curled end of the Trip Plate Rod (if not already inserted) is inserted from underneath the Trip Plate in an upward direction, through the hole in the Trip Plate and twisted clockwise until the curled end of the Trip Plate Rod is facing downward. If the curled end of the Trip Plate Rod is NOT facing downward the Trip Plate Rod may fall through the hole and the trap will not be set correctly. Connect the U shaped top of the Trip Plate Rod to the J-Hook mechanism located above the trap door. (Figure 6).*

**Note – the end of the U shape should be facing down and not up and should attach to the J-Hook mechanism simply if the curled end of the Trip Plate Rod has been positioned correctly as explained above.*

INSTRUCTIONS TO SET THE ANIMAL TRAP

1. Place the trap on a flat even surface. If possible place the trap against a wall or building or in a path commonly used by the animal.
2. The trap can be baited by opening the rear door and placing food about 2-3cm from the rear door. Do not place bait on the Trip Plate. Place the bait in a position that will force the animal to step on the Trip Plate. Once the bait is set, the rear door can be closed and the wire lock (small square U shaped wire) can be inserted through the designated holes and door rings to ensure the door doesn't open. The hook on the end of the lock should be hooked over the trap mesh to secure the lock.
3. Pull up the trap door by squeezing down the door lock frame with your thumb and at the same time pulling up the trap door using the door handle on the spring system.
4. Holding up the trap door with one hand, slide the trap door hook (J-hook mechanism) under the bar of the trap door to hold the trap door in up in place.
- *Note – if the hook does not stay positioned under the trap door the J-hook mechanism can be adjusted using pliers to move the trap door hook forward or the J-hook mechanism back. The position of the trap door hook can also be used when capturing lighter animals for example where the tip of the hook is positioned to hold up the trap door enabling a lighter animal to set the trap off.*
5. The trap is now ready for use.
6. It is often beneficial to camouflage the trap with materials normally found in the trapping area such as vegetation, sack cloth, boxes etc. If camouflaging/hiding the trap ensure materials do not interfere with the operation of the trap parts.
7. Check the trap regularly to ensure trapped animals are in good condition.

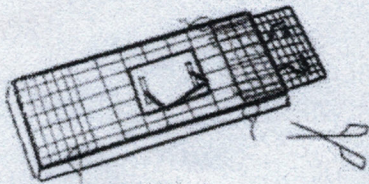

FIGURE 1

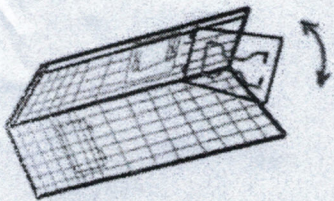

FIGURE 2

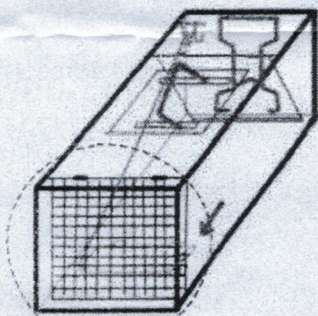

FIGURE 3

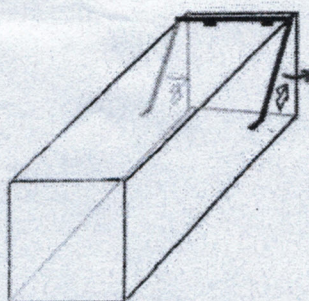
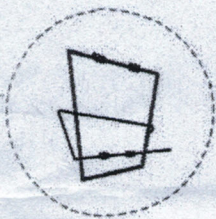

FIGURE 4

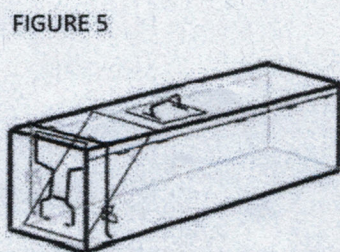

FIGURE 5

J-Hook rod connection

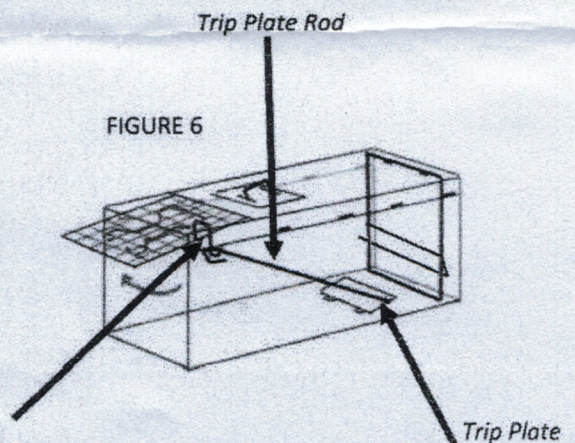

FIGURE 6

Trip Plate